



MACCHINE PER LA BIOAGRICOLTURA



















**2023**











INDUSTRIA 4.0



# indice

	EXPO SINGOLO H / B / R ECO / R TOP / P	<b>4</b>
	EXPO SINGOLO P	<b>6</b>
	EXPO SINGOLO SMART	<b>7</b>
	FRUTTETO SINGOLO / FRUTTETO DOPPIO	<b>8</b>
	EXPO DOPPIO H / ECO / TOP / FULL / P	<b>10</b>
	OLIVER / ARES	<b>12</b>
	VENTRALE M / VENTRALE B / VENTRALE P	<b>13</b>
	EXPO DOPPIO P	<b>14</b>
	EXPO DOPPIO SMART	<b>15</b>
	VITTORIA H / B / R ECO / R TOP	<b>16</b>
	SAN SALVO H / ECO / TOP	<b>17</b>
	FUTURA H / ECO / TOP / FULL	<b>18</b>
	FUTURA ECO SPECIAL / TOP SPECIAL / FULL SPECIAL	<b>20</b>
	FUTURA TOP JUNIOR / FULL JUNIOR	<b>21</b>
	SPOL SINGOLA / SPOL DOPPIA	<b>22</b>
	TRINCIERBA SINGOLO / TRINCIERBA DOPPIO	<b>23</b>

# indice

	ANDANATORE PER SARMENTI "TWIST"	<b>24</b>
	TECNOLOGIA 4.0 / CENTRALINA 3 PUNTI	<b>25</b>
	ARIEGGIATORE ED INTERRATORE DI CONCIME / INTERRATORE DI CONCIME	<b>26</b>
	PIANTAPALI LATERALE / PIANTAPALI POSTERIORE	<b>28</b>
	RIPUNTATORE SPIDER 1 / RIPUNTATORE SPIDER 5	<b>29</b>
	COLTIVATORE BASIC / ARIEGGIATORE "MAXI"	<b>30</b>
	VIBROCULTORE V / VB / VBR / COLTIVATORE CLP	<b>31</b>
	RASTRELLO PER SARMENTI / VASCA INFORCABILE / BENNA IDRAULICA	<b>32</b>
	APPLICAZIONI MOTRICI	<b>33</b>
	APPLICAZIONI NON MOTRICI	<b>34</b>
	BREVETTO VALVOLA BREVETTATA NO-STOP / OPTIONAL BLOCCO ROTAZIONE / OPTIONAL DISATTIVA TASTATORE	<b>36</b>
	REVERSIBILITÀ TOTALE / 4 PRESE DI FORZA / BREVETTO SALITA-DISCESA	<b>37</b>
	PUNTI DI FORZA	<b>38</b>

# EXPO SINGOLO

- █ Porta attrezzi con lama interceppo idraulica DX. E' utilizzato nelle aziende nelle quali viene praticata la non coltura del filare, lavorando solo l'interceppo.
- █ Tool carrier with RH hydraulic inter-row blade. It is used in companies where no-cultivation is employed, working only the lane.
- █ Porte-outils avec lame ouillere hydraulique D. Est utilise dans les exploitations ob on ne pratique pas la culture de la rangee, labourant seulement entre les souches.
- █ Porta equipos con cuchilla intercepas hidraulica DCH. Es utilizado en las empresas se practica el no cultivo del filar, trabajando solamente el interceppo.

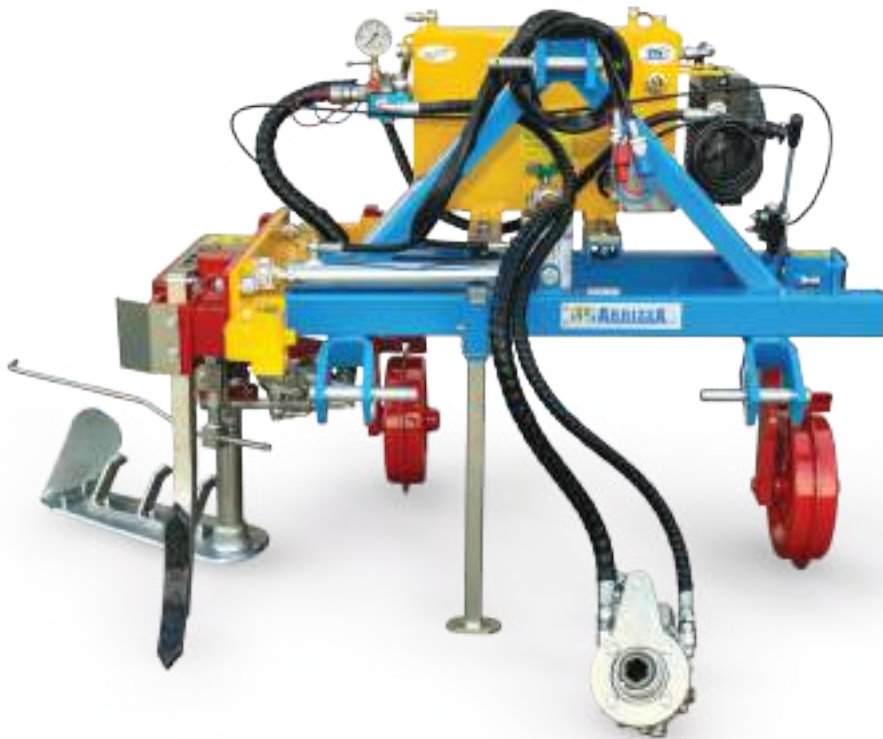

EXPO SINGOLO H

EXPO SINGOLO B

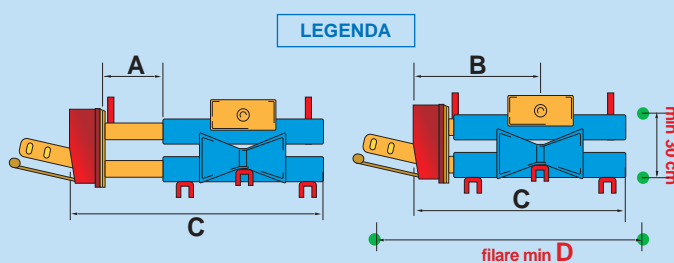

**VERS.H**

Mod.	A (cm)	B (cm)	C (cm)	D (cm)
HS	30	58	112 / 142	165
H	30	70	130 / 160	190
HX	30	94	150 / 180	235

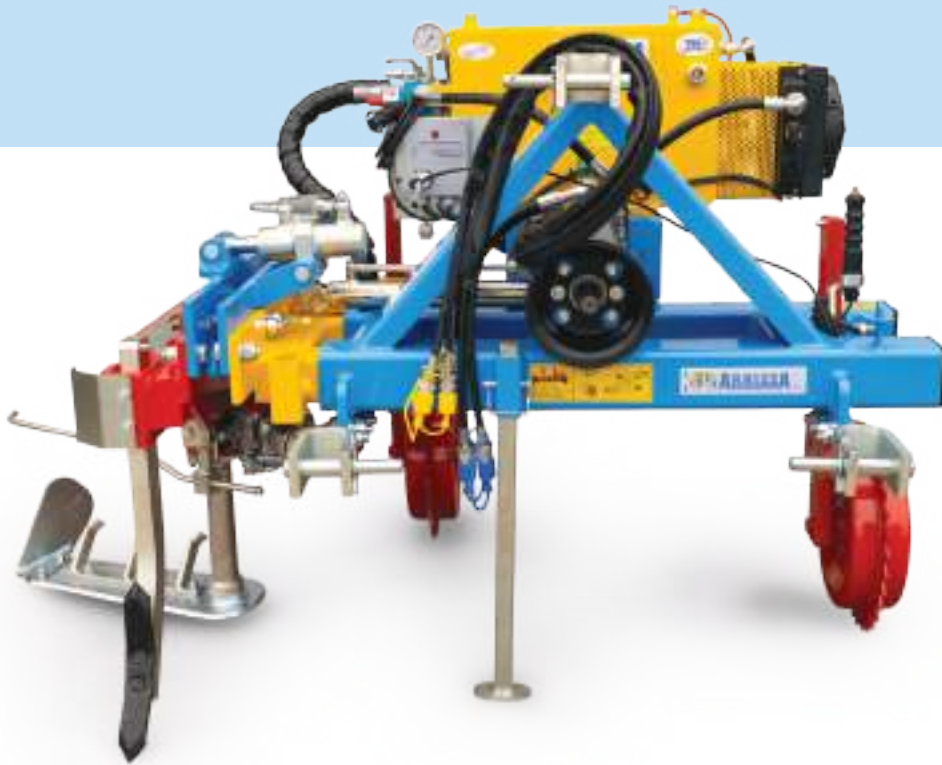

*EXPO SINGOLO R ECO*

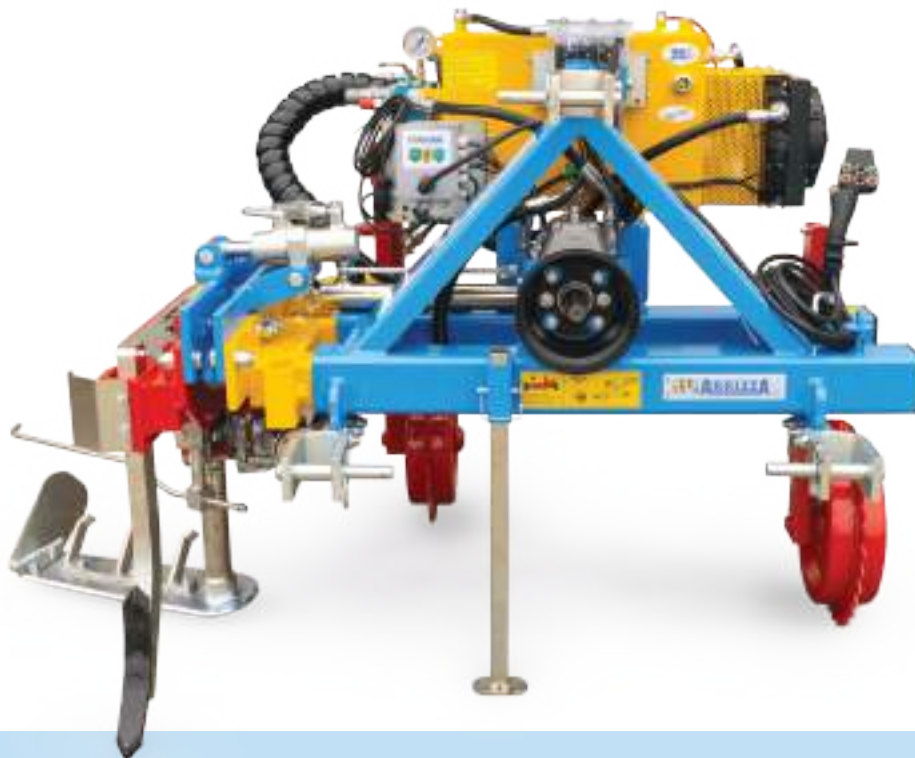

*EXPO SINGOLO R TOP*

**VERS. B**

Mod.	A (cm)	B (cm)	C (cm)	D (cm)
B 1S	30	50	95 / 125	150
B 1	40	60	110 / 150	170
B 2	40	74	130 / 170	200

**VERS. R ECO / TOP**

Mod.	A (cm)	B (cm)	C (cm)	D (cm)
R ECO 1S - R TOP 1S	30	56	102 / 132	160
R ECO 1 - R TOP 1	40	66	115 / 155	180
R ECO 2 - R TOP 2	40	80	137 / 177	200

# EXPO SINGOLO P

🇮🇹 Porta attrezzi con allargamento idraulico. E' utilizzato nelle aziende nelle quali viene praticata la non coltura del flare, lavorando solo l'interceppo.

🇬🇧 Tool carrier with hydraulic widening. It is used in companies where no-cultivation is employed, working only the lane.

🇫🇷 Porte-outils avec elargissement hydraulique. Est utilise dans les exploitations oil on ne pratique pas la culture de la rangee, labourant seulement entre les couches.

🇪🇸 Porta equipos con extension lateral hidraulica DCH. Es utilizado en las empresas se practica el no cultivo del filar, trabajando solamente el interceppo.



**NEW VERSION**



EXPO SINGOLO P

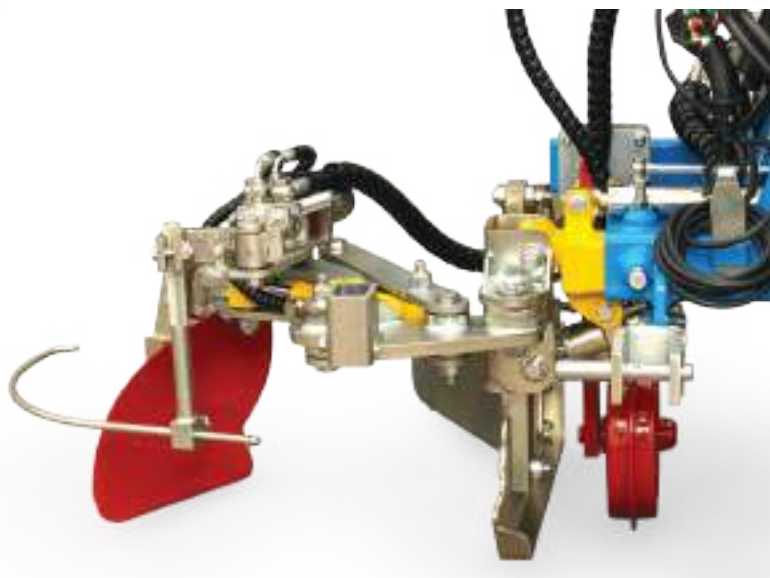



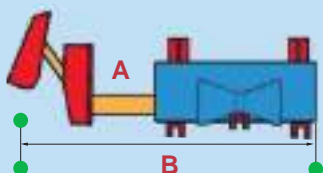

## LEGENDA



Mod.	A (cm)	B (cm)	Filare min (cm)
P1	30	173	193
P2	40	195	205
P3	50	220	220

# EXPO SINGOLO SMART

-  Porta attrezzi con allargamento idraulico. E' utilizzato nelle aziende nelle quali viene praticata la non coltura del file, lavorando solo l'interceppo.
-  Tool carrier with hydraulic widening. It is used in companies where no-cultivation is employed, working only the lane.
-  Porte-outils avec elargissement hydraulique. Est utilise dans les exploitations oil on ne pratique pas la culture de la rangee, labourant seulement entre les souches.
-  Porta equipos con extension lateral hidraulica DCH. Es utilizado en las empresas se practice el no cultivo del filar, trabajando solamente el interceppo.



EXPO SINGOLO SMART



Expo Singolo Smart anteriore o posteriore (misure espresse in cm)		ACCESSORI						
		Disco dentato rinalzante orientabile	Dischiera a 2 dischi dentati rinalzanti	Dischiera sarchiatrice a 2 stelle + stella a dita rossa Ø540	Dischiera sarchiatrice a 3 stelle + stella a dita rossa Ø540	Dischiera sarchiatrice a 3 stelle + stella a dita gialla Ø700	Trinciaerba a fili corti con innesti rapidi	Spollonatrice idraulica con innesti rapidi
Versione	1 POST	L min 105	L min 120	L min 118	L min 128	L min 128	L min 122	L min 118
	1 ANT	L min 112	L min 127	L min 125	L min 135	L min 135	L min 119	non compatibile
	2 POST	L min 115	L min 130	L min 128	L min 138	L min 138	L min 132	L min 128
	2 ANT	L min 122	L min 137	L min 135	L min 145	L min 145	L min 139	solo con inclinazione idraulica L min 155
	3 POST	L min 130	L min 145	L min 143	L min 153	L min 153	L min 147	L min 143
	3 ANT	L min 137	L min 152	L min 150	L min 160	L min 160	L min 154	L min 163

ANTERIORE

POSTERIORE

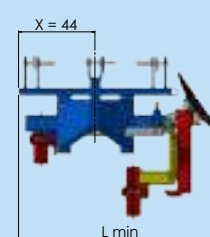
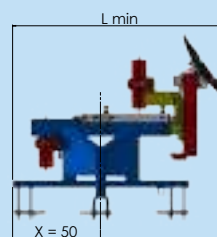

La distanza dal 3° punto del telaio all'ingombro minimo dell'utensile installato data dalla differenza tra "L min" (Vedi tabella misure) e X

# FRUTTETO SINGOLO

- █ █ Porta attrezzi con lama interceppo idraulica DX. Ideale per frutteti a chioma bassa e per vigneti con filari minimo 230 cm.
- █ █ Tool carrier with RH hydraulic inter-row blade. Ideal for low orchards and for vineyards with rows min 230 cm.
- █ █ Porte-outils avec lame ouillere hydraulique D. Ideal pour arboricole basse et pour vignobles de 230 cm min.
- █ █ Porta equipos con cuchilla intercepas hidraulica DCH. Ideal por huertos a cabellera baja y por virias con hileras minimo 230 cm.



## VERS. 1

- █ █ Per la larghezza di lavoro massima a necessario considerare l'allargamento laterale di 40 cm con joystick multifunzione.
- █ █ For maximum work widths is necessary to consider 40 cm hydraulic side operation with multi-function joystick.
- █ █ Pour les largeurs de travail maximale est necessaire considerer l'elargissement lateral hydraulique 40 cm avec joystick multifonction.
- █ █ Para las anchos de trabajo maxima es necesario considerar la extension lateral hidraulica 40 cm con joystick multifuncion.

## VERS. 2

- █ █ Per la larghezza di lavoro massima a necessario considerare l'allargamento laterale di 40 cm con joystick multifunzione e l'allargamento laterale con parallelogramma di 103 cm con 2 innesti rapidi al trattore.
- █ █ For maximum work widths is necessary to consider cm 40 hydraulic side operation with multi-function joystick and cm 103 hydraulic side operation with parallelogram and 2 quick tractor couplings.
- █ █ Pour les largeurs de travail maximale est necessaire considerer l'elargissement lateral hydraulique 40 cm avec joystick multifonction et elargissement lateral hydraulique 103 cm avec parallelogramme a 2 endenchements rapides au tracteur.
- █ █ Para las anchos de trabajo maxima es necesario considerar la extension lateral hidraulica 40 cm con joystick multifuncion y la extension lateral hidraulica con paralelogramo de 103 cm con 2 enchufes rapidos al tractor.

LARGHEZZA DI LAVORO FRUTTETO VERSIONE 1

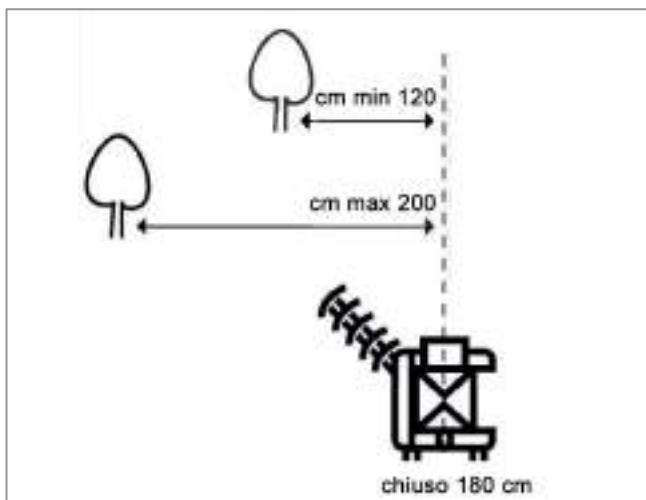



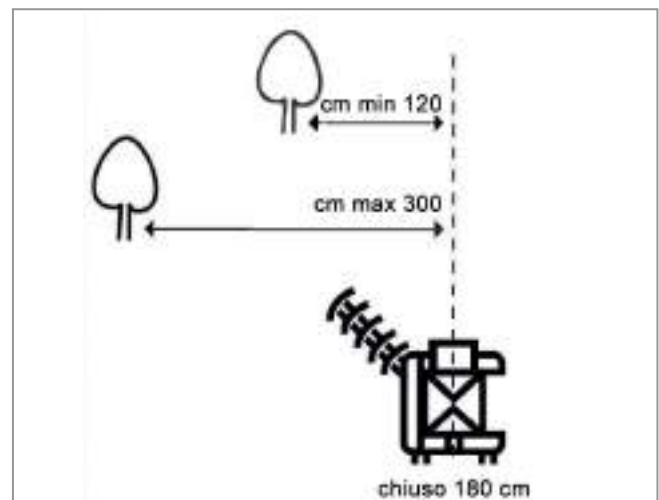

LARGHEZZA DI LAVORO FRUTTETO VERSIONE 2





# FRUTTETO DOPPIO

-  Porta attrezzi con lame interceppo idrauliche DX / SX. Ideale per frutteti a chioma bassa e per vigneti con filari minimo 190 cm
-  Tool carrier with RH / LH hydraulic inter-row blades. Ideal for low orchards and for vineyards with rows min 190 cm.
-  Porte-outils avec lame ouillère hydraulique D / G. Idéal pour arboricole basse et pour vignobles de 190 cm min.
-  Porta equipos con cuchilla intercepa hidráulica DCH. / IZQ. Ideal por huertos a cabellera baja y porviñas con hileras mínimo 190 cm.

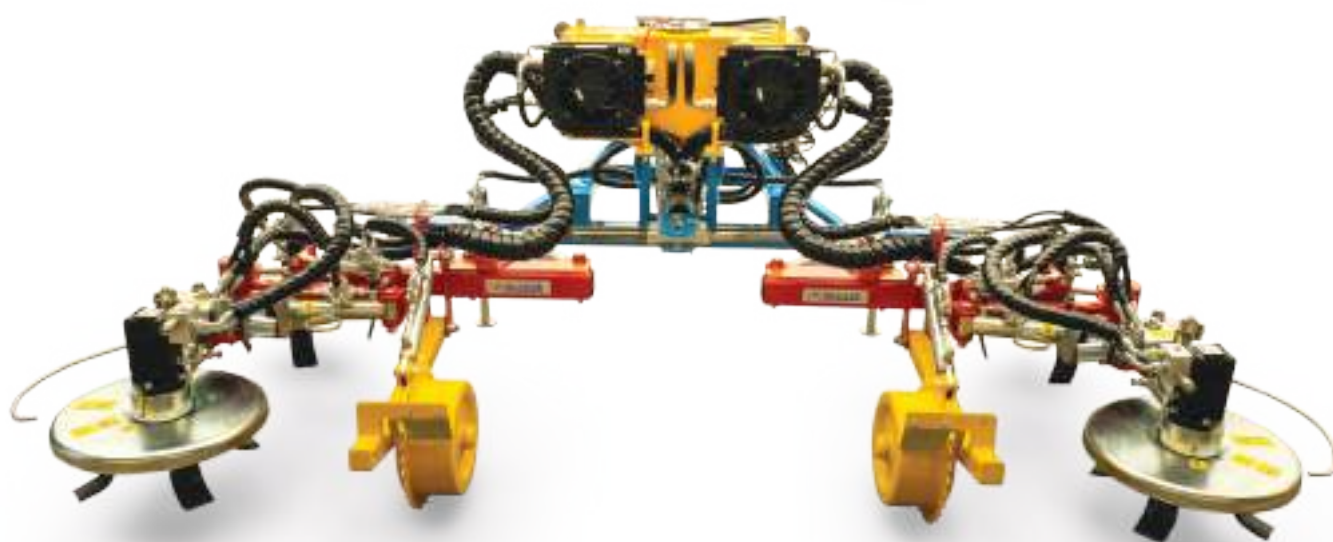

## LARGHEZZE DI LAVORO MACCHINA- MACHINE WORK WIDTHS

### LARGHEZZE DI LAVORO MACCHINA- VER.1

MACCHINA CHIUSA CON 2 LAME: 165 CM

### LARGHEZZE DI LAVORO CON UTENSILI

CON 2 LAME DA 65 CM: MIN 250 CM / MAX 430 CM

CON 2 LAME DA 85 CM: MIN 250 CM / MAX 470 CM

CON 2 FRESINI / SCALZATORI ROTATIVI DIAM 50 CM: MIN 200 / MAX 370 CM

CON 2 TRINCIAERBA A LAME DA 80 CM: MIN 280 CM / MAX 410 CM

CON 2 DISCHIERE 3 DISCHI SCALZANTI: MIN 250 CM / MAX 390 CM

CON 2 DISCHIERE 5 DISCHI SCALZANTI: MIN 290 CM / MAX 450 CM

CON 2 TRINCIAERBA A FILI VERTICALI: MIN 220 CM / MAX 390 CM

### LARGHEZZE DI LAVORO MACCHINA- VER.2

MACCHINA CHIUSA CON 2 LAME: 250 CM

### LARGHEZZE DI LAVORO CON UTENSILI

CON 2 LAME DA 65 CM: MIN 340 CM / MAX 520 CM

CON 2 LAME DA 85 CM: MIN 340 CM / MAX 560 CM

CON 2 FRESINI / SCALZATORI ROTATIVI DIAM 50 CM: MIN 320 / MAX 460 CM

CON 2 TRINCIAERBA A LAME DA 80 CM: MIN 370 CM / MAX 500 CM

CON 2 DISCHIERE 3 DISCHI SCALZANTI: MIN 340 CM / MAX 480 CM

CON 2 DISCHIERE 5 DISCHI SCALZANTI: MIN 380 CM / MAX 540 CM

CON 2 TRINCIAERBA A FILI VERTICALI: MIN 310 CM / MAX 480 CM

# EXPO DOPPIO

- █ Porta attrezzi con doppia lama interceppo idraulica DX / SX. Ideale per soddisfare le esigenze delle aziende che praticano la non coltura centrale, lavorando solo l'interceppo.
- █ Tool carrier with RH / LH double hydraulic inter-row blade. Possibility for companies working a no-central cultivation, only the lanes.
- █ Porte-outils avec double lame ouillère hydraulique D / G. Idéal pour les exploitations qui ne pratiquent pas la culture centrale, en labourant seulement entre les souches.
- █ Porta equipos con doble cuchilla intercepas hidráulica a DCH. / IZQ. Ideal para aquellas empresas que practican el no cultivo central, trabajando solo el interceppo.

**EXPO DOPPIO H**



**EXPO DOPPIO ECO**



## VERSIONI CON TELAIO AD ALLARGAMENTO STANDARD / STANDARD EXTENSION VERSIONS

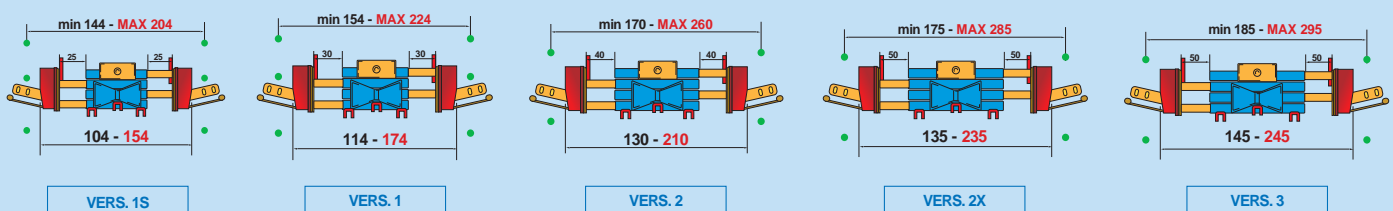



EXPO DOPPIO TOP



EXPO DOPPIO FULL

- █ Rispetto alle misure indicate, le versioni FULL hanno un ingombro maggiore di 10 cm in quanto montano di serie i kit per l'inclinazione laterale delle lame.
- █ With the application of the hydraulic blades inclinations RH / LH, the tools dimensions increase by 10 cm.
- █ Avec l'application de l'inclinaisons hydrauliques lame D / G, l'encombrement de l'outils augmentera de 10 cm.
- █ Con la aplicación des los inclinaciones hidráulico de las cuchillas DCH. / IZQ., las dimensiones del equipo aumentará de cm 10.

**VERSIONI CON TELAIO TELESCOPICO / TELESCOPIC VERSIONS**

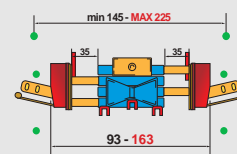

H, ECO, TOP vers. TEDESC. 1S

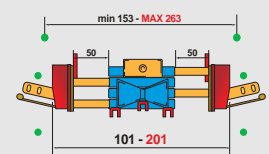

H, ECO, TOP vers. TEDESC. 1

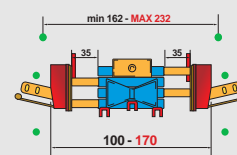

FULL vers. TEDESC. 1S

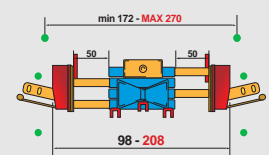

FULL vers. TEDESC. 1

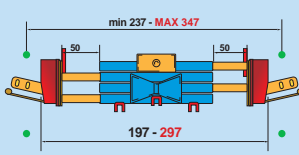

VERS. 4

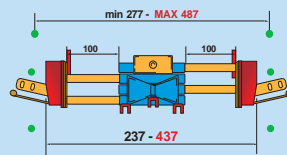

VERS. 4X

# OLIVER

- █ Porta attrezzi con lame interceppo idrauliche DX/SX disponibile nelle versioni posteriore o anteriore. Ideale per oliveti e frutteti con filari minimo 300cm.
- █ Tool carrier with RH/LH hydraulic inter-row blades available in rear or front versions. Ideal for olive groves and orchards with rows of at least 300cm.
- █ Porte-outils avec lames inter-rangs hydrauliques D/G disponible en versions arrière ou avant Idéal pour les oliveraies et les vergers avec des rangées d'au moins 300cm.
- █ Porta implementos con cuchillas hidráulicas entre hileras DCH./IZQ disponible en versiones trasera o delantera. Ideal para olivares y huertas con hileras de al menos 300cm.



**NEW**

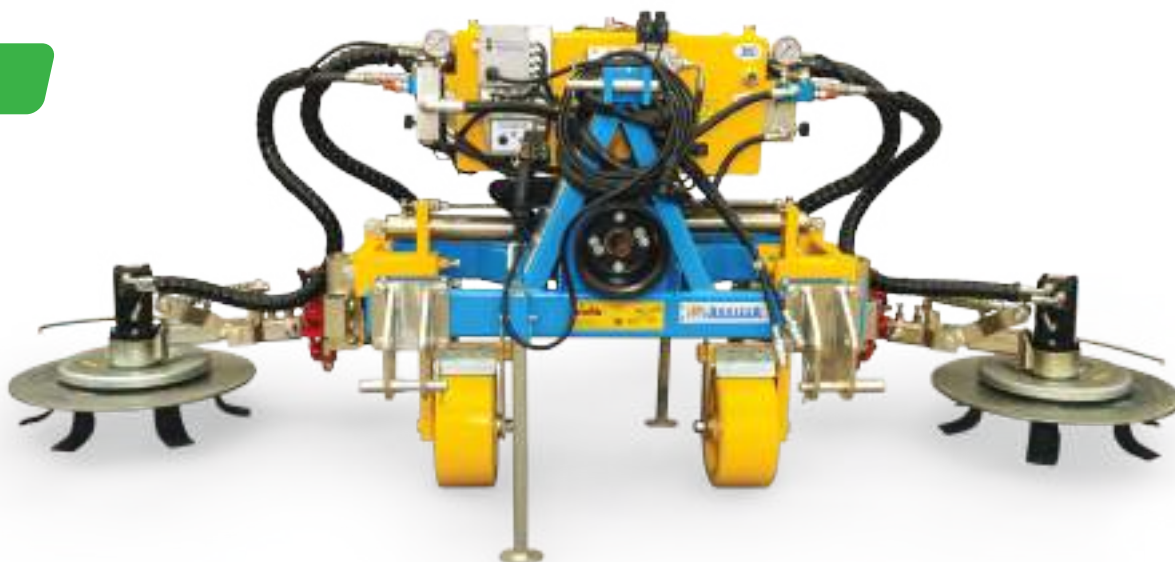

## LARGHEZZE DI LAVORO MACCHINA- MACHINE WORK WIDTHS

### LARGHEZZE MACCHINA – VER.1

MACCHINA CHIUSA SENZA ACCESSORI: 205 CM

CON ACCESSORI : MIN 300 CM / MAX 420 CM

### LARGHEZZE MACCHINA – VER.2

MACCHINA CHIUSA SENZA ACCESSORI: 205 CM

CON ACCESSORI : MIN 300 CM / MAX 500 CM

# ARES

- █ Porta attrezzi con allargamento idraulico. E' utilizzato nelle aziende nelle quali viene praticata la non coltura del filare, lavorando solo l'interceppo.
- █ Tool carrier with hydraulic widening. Used in farms where the no-crop row is practised, working only the inter-row.
- █ Porte-outils avec elargissement hydraulique. Est utilisé dans les entreprises on ne pratique pas la culture de la rangee, labourant seulement l'intercep.
- █ Porta implementos con extension lateral hidráulica. Es utilizado en las empresas se practica el no cultivo del filar, trabajando solamente el interceppo.

**NEW**

- █ Alimentato dall'impianto idraulico del trattore
- █ Powered by the tractor's hydraulic system
- █ Alimenté par le système hydraulique du tracteur
- █ Alimentado por el sistema hidráulico del tractor



## LARGHEZZE DI LAVORO MACCHINA – MACHINE WORK WIDTHS VEDI PAGINE 10 E 11

# VENTRALE

- 🇮🇹 Porta attrezzi con lama interceppo idraulica DX. E' utilizzato nelle aziende nelle quali viene praticata la non coltura del filare, lavorando solo l'interceppo.
- 🇬🇧 Tool carrier with RH hydraulic inter-row blade. It is used in companies where no-cultivation is employed, working only the lane.
- 🇫🇷 Porte-outils avec lame ouillere hydraulique D. Est utilise dans les exploitations ob on ne pratique pas la culture de la rangee, labourant seulement entre les souches.
- 🇪🇸 Porta equipos con cuchilla intercepas hidraulica DCH. Es utilizado en las empresas se practica el no cultivo del filar, trabajando solamente el intercepo.

VENTRALE DX/SX "M"

**NEW**



- 🇮🇹 VENTRALE DX / SX
- 🇬🇧 RH / LH VENTRAL
- 🇫🇷 ENTRE ROUES D / G
- 🇪🇸 ENTRE LE RUEDAS DCH. / IZQ

VENTRALE DX/SX "B"



VENTRALE DX/SX "P"



# EXPO DOPPIO P

- █ Porta attrezzi con allargamento ed inclinazione innesti rapidi al trattore. E' utilizzato nelle aziende nelle quali viene praticata la non coltura centrale, lavorando solo l'interceppo.
- █ Tool carrier with hydraulic widening and inclination on quick tractor couplings. It is used in companies where no-cultivation is employed, working only the inter-row.
- █ Porte-outils avec. Est utilisé dans les exploitations où on ne pratique pas la culture de la rangée, labourant seulement entre les souches.
- █ Porta equipos con. Es utilizado en las empresas se practica el no cultivo del ilar, trabajando solamente el interceppo.



**NEW VERSION**

**EXPO DOPPIO P**

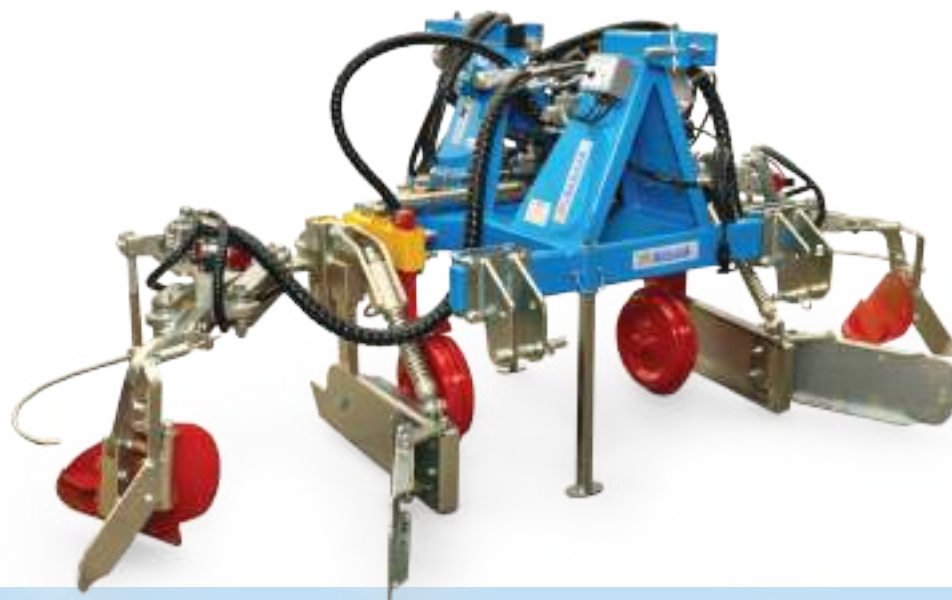

Modello / Larghezze di lavoro	Kit lama interfilare / Kit aratro scalzante	Stella a dita Dischiera sarchiatrice
Expo doppio P 1XXS	min 170 / max 200	min 150 / max 215
Expo doppio P 1XS	min 185 / max 215	min 170 / max 200
Expo doppio P 1S	min 195 / max 235	min 185 / max 215
Expo doppio P 1	min 215 / max 285	min 205 / max 265
Expo doppio P 2	min 235 / max 325	min 225 / max 305
Expo doppio P 3	min 265 / max 375	min 255 / max 355
Expo doppio P 4	min 270 / max 405	min 260 / max 385

# EXPO DOPPIO SMART

- █ Porta attrezzi con allargamento idraulico. E' utilizzato nelle aziende nelle quali viene praticata la non coltura del flare, lavorando solo l'interceppo.
- █ Tool carrier with hydraulic widening. It is used in companies where no-cultivation is employed, working only the lane. Porte-outils avec elargissement hydraulique.
- █ Est utilise dans les exploitations ou on ne pratique pas la culture de la rangee, labourant seulement entre les souches.
- █ Porta equipos con extension lateral hidraulica. Es utilizado en las empresas se practica el no cultivo del filar, trabajando solamente el interceppo.

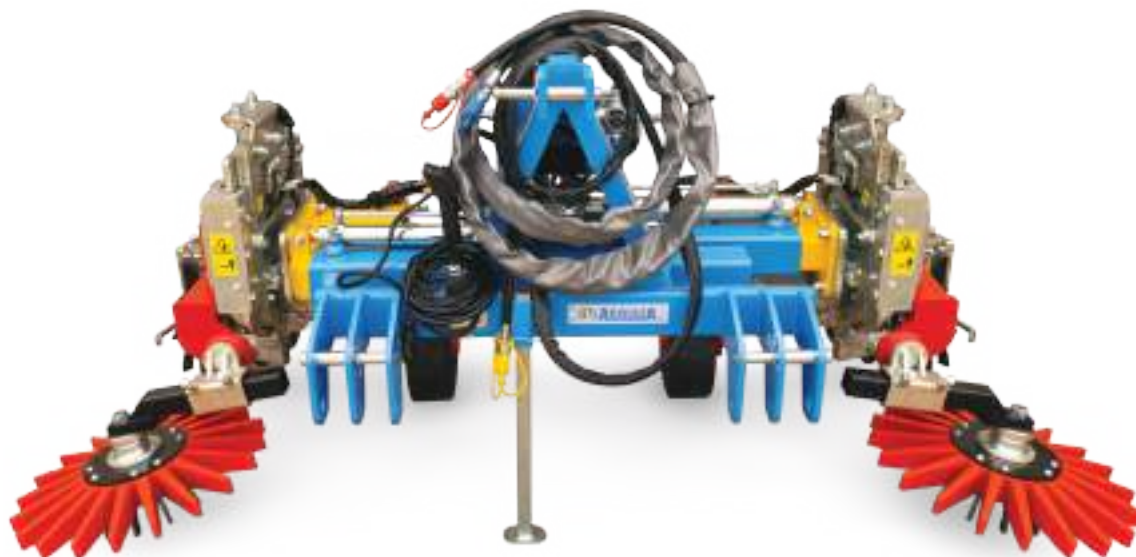





EXPO DOPPIO SMART

- █ REVERSIBILE DI SERIE
- █ REVERSIBILE AS STANDARD
- █ RÉVERSIBLE DE SÉRIE
- █ REVERSIBLE DE SERIE



EXPO DOPPIO SMART REVERSIBILE (MISURE ESPRESSE IN CM)		ACCESSORI						
		DISCHI DENTATI RINCALZANTI ORIENTABILI	DISCHIERE A 2 DISCHI DENTATI RINCALZANTI	DISCHIERE SARCHIATRICI A 2 STELLE + STELLE A DITA ROSSE 0540	DISCHIERE SARCHIATRICI A 3 STELLE + STELLE A DITA ROSSE 0540	DISCHIERE SARCHIATRICI A 3 STELLE + STELLE A DITA GIALLE 0700	TRINCIAERBA A FILL CORTI CON INNESTI RAPIDI	SPOLLONATRICI IDRAULICHE CON INNESTI RAPIDI
VERSIONE	1	MIN 100 MAX 155	MIN 155 MAX 215	MIN 150 MAX 210	MIN 170 MAX 230	MIN 170 MAX 230	MIN 158 MAX 218	SOLO VERS. POSTERIORE MIN 161 / MAX 221
	2	MIN 115 MAX 195	MIN 175 MAX 255	MIN 170 MAX 250	MIN 190 MAX 270	MIN 190 MAX 270	MIN 178 MAX 258	VERS. ANTERIORE MIN 181 / MAX 261 REVERSIBILITY SOLO CON INCLINAZIONI (INGOMBRO TOTALE + 14 CM RISPETTO LE MISURE INDICATE)
	3	MIN 145 MAX 245	MIN 204 MAX 304	MIN 200 MAX 300	MIN 220 MAX 320	MIN 220 MAX 320	MIN 208 MAX 308	MIN 211 MAX 311

# VITTORIA

-  Coltivatore con lama interceppo idraulica DX. Ideale per la lavorazione del filare e dell'interceppo.
-  Cultivator with RH hydraulic inter-row blade. Ideal for working rows and lane.
-  Cultivateur avec lame ouillère hydraulique D. Idéal pour le labourage de la rangée et intercep.
-  Cultivador con cuchilla intercepas hidráulica DCH. Ideal para trabajar el filar y el intercepo.



VITTORIA H



VITTORIA B







VITTORIA R ECO

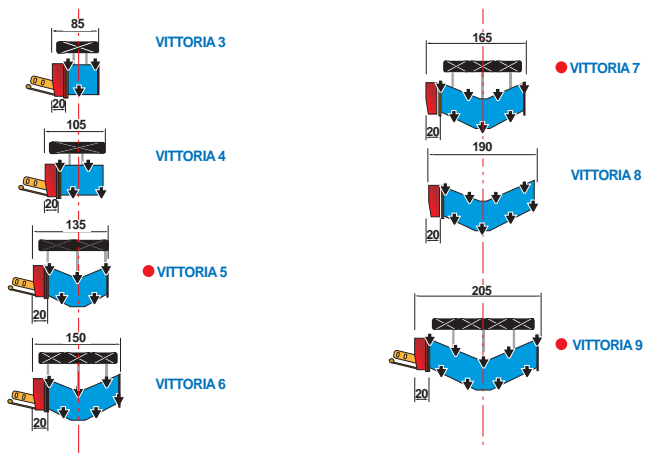





VITTORIA R TOP



- Modello con ingombro disassato rispetto al trattore
  - Model with no stony obstruction compared to the tractor
  - Modèle avec encombré non centré par rapport à le tracteur
  - Modelo con lleno no centrado respecto al tractor
-  Rispetto alle misure indicate, le versioni R hanno un ingombro maggiore di 5 cm in quanto montano di serie il kit per l'inclinazione laterale della lama.
-  With the application of the hydraulic blade inclination RH, the tool dimensions increase by 5 cm.
-  Avec l'application de l'inclinaison hydraulique lame D, l'encombrement de l'outil augmentera de 5 cm.
-  Con la aplicación de la inclinación hidráulica de la cuchilla DCH., el espacio del equipo aumentará unos cm 5.



# SAN SALVO

-  Coltivatore dotato di una prolunga laterale DX (60 e 100 cm) con lama interceppo idraulica. Ideale per frutteti, oliveti e agrumeti con impianto a vaso.
-  Cultivator with RH hydraulic inter-row blade. Ideal for work rows and lane of orchards. Lateral extension available of 60 or 100 cm.
-  Cultivateur avec lame ouillère hydraulique D et rallonge de 60 ou 100 cm. Idéal pour le labourage de l'intercep et les rangées des cultures fruitières, comme les pêchers, les oliviers et les agrumeraies avec plantation en vase.
-  Cultivador con extensión lateral de cm 60 o 100 y con cuchilla intercepas hidráulica DCH. Ideal para trabajar el fila y el intercepo de frutales.



SAN SALVO H

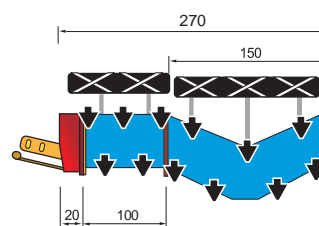
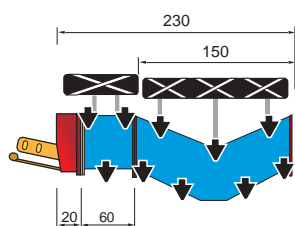

# FUTURA

- █ Coltivatore con doppia lama interceppo idraulica. Dà la possibilità di lavorare l'interceppo contemporaneamente a DX e SX ed il filare
- █ Cultivator with dual RH / LH hydraulic inter-row blades. Ideal to work simultaneously in the rows and lanes.
- █ Cultivateur avec double lame ouillère hydraulique D / G. Il donne la possibilité de travailler entre les rangées et l'intercep simultanément.
- █ Cultivador con doble cuchilla intercepas hidráulica DCH. / IZQ. Da la posibilidad de trabajar el intercepas contemporáneamente a DCH. y el fila .

FUTURA H



FUTURA ECO

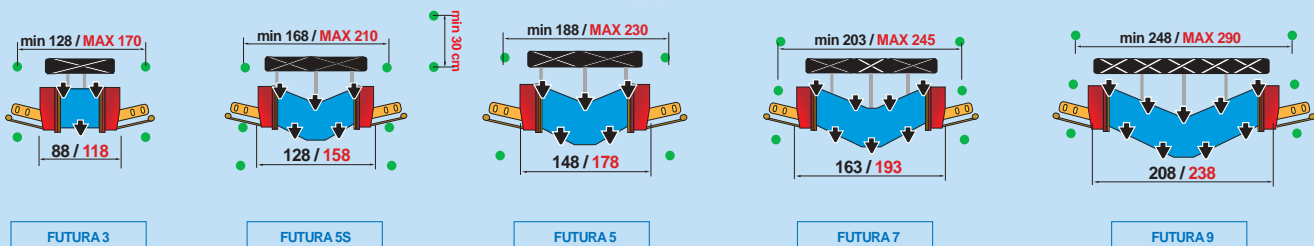











**FUTURA TOP**



**FUTURA FULL**

-  Rispetto alle misure indicate, le versioni FULL hanno un ingombro maggiore di 10 cm in quanto montano di serie i kit per l'inclinazione laterale delle lame.
-  With the application of the hydraulic blades inclinations RH / LH , the tools dimensions increase by 10 cm.
-  Avec l'application de l'inclinaisons hydrauliques lames D / G, l'encombrement de l'outil augmentera de 10 cm.
-  Con la aplicación des los inclinaciones hidráulico de las cuchillas DCH. / IZQ., el espacio del equipo aumentará unos cm 10.

# FUTURA SPECIAL



-  Coltivatore con doppia lama interceppo idraulica DX / SX e molle con sgancio rapido. Ideale per soddisfare le esigenze delle aziende che hanno vigneti di diverse larghezze.
-  Cultivator with double hydraulic inter row RH / LH and rapid unhook spring. Ideal for satisfying the demands of the companies that have vineyards of different widths.
-  Cultivateur avec double lame ouilliere hydraulique D / G et ressorts décroche rapide. Ideal pour satisfaire les exigences des usines qui ont vignobles de différentes largeurs.
-  Cultivador con doble cuchillas intercepas hidraulico DCH. / IZQ. y muelles desengancho rapido. Ideal para satisfacer las exigencias de las empresas que tienen visas de muchos anchos.



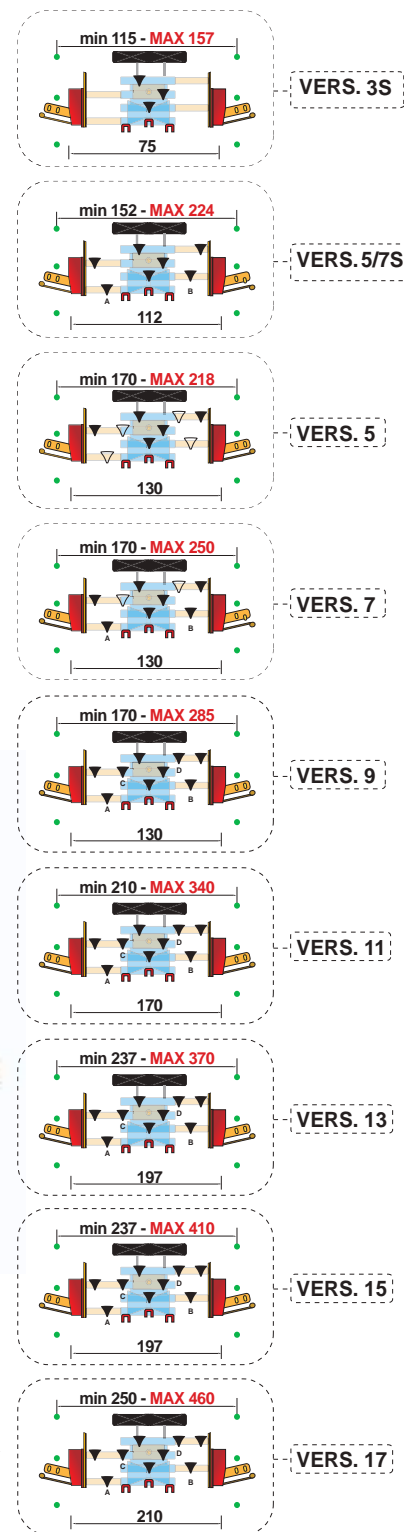





FUTURA ECO/TOP SPECIAL



FUTURA FULL SPECIAL

model			
FUTURA eco special tel. 5	50 + 50	110	150 / 200
FUTURA eco special tel. 7	50 + 50	110	150 / 230
FUTURA eco special tel. 9	50 + 50	110	150 / 260
FUTURA top special tel. 5	50 + 50	110	150 / 200
FUTURA top special tel. 7	50 + 50	110	150 / 230
FUTURA top special tel. 9	50 + 50	110	150 / 260
FUTURA full special tel. 5	50 + 50	120	170 / 210
FUTURA full special tel. 7	50 + 50	120	170 / 242
FUTURA full special tel. 9	50 + 50	120	170 / 270

-  molle fisse di serie  
fixed standard spring  
ressort fixes de serie  
resorte fijo de serie
-  molle con sgancio rapido optional rapid unhook  
spring optional  
ressort d'ocroche rapide option muelles  
desengancho rapido opcional

-  Rispetto alle misure indicate, le versioni FULL hanno un ingombro maggiore di 10 cm in quanto montano di serie i kit per l'inclinazione laterale delle lame.
-  With the application of the hydraulic blades inclinations RH / LH , the tools dimensions increase by 10 cm.
-  Avec l'application de l'inclinaisons hydrauliques lames D / G, l'encombrement de l'outil augmentera de 10 cm.
-  Con la aplicacion des los inclinaciones hidraulico de las cuchillas DCH. / IZQ., el espacio del equipo aumentara unos cm 10.

# FUTURA JUNIOR

- 🇮🇹 Coltivatore con sistema di salita e discesa di serie e doppia lama interceppo idraulica. Da la possibility di lavorare rinterceppo contemporaneamente a DX e SX ed il filare.
- 🇬🇧 Cultivator with up/down hydraulic system and dual RH / LH hydraulic inter-row blades. Ideal for work simultaneously in the rows and lanes.
- 🇫🇷 Cultivateur avec systeme de montee/descente et double lame ouillere hydraulique D / G. Il donne la possibility de labourer entre les rangees et l'intercep simultanement.
- 🇪🇸 Cultivador con sistema hidraulico de subida/bajada y doble cuchilla intercepas hidraulica DCH. / IZQ. y el filar. Da la posibilidad de trabajar el intercepas contemporaneamente a DCH. y IZQ. y el filar.



FUTURA TOP JUNIOR



FUTURA FULL JUNIOR

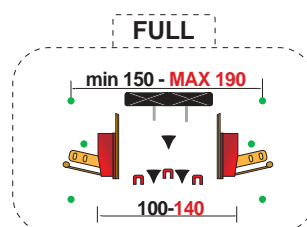
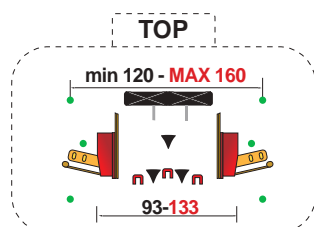

# SPOL SINGOLA

## SPOL DOPPIA



### SPOL SINGOLA

- 🇮🇹 Telaio con attacco a 3 punti registrabile in larghezza / altezza, con spollonatrice idraulica
- 🇬🇧 Rotary brush frame with adjustable width / depth 3 point coupling
- 🇫🇷 Chassis epampreuse avec attaque 3 point réglable en largeur / hauteur
- 🇪🇸 Chasis cepillo rotor con ataque 3 puntos y ajustables en ancho / extension



### SPOL DOPPIA

- 🇮🇹 Telaio con attacco a 3 punti posteriore registrabile in larghezza / altezza, con spollonatrici idrauliche
- 🇬🇧 Rotary brushes rear frame with adjustable width / depth 3 point coupling
- 🇫🇷 Chassis epampreuses arriere avec attaque 3 point et réglable en largeur / hauteur
- 🇪🇸 Chasis cercenadoras rotor con ataque 3 puntos trasero y ajustables en ancho / extension



# TRINCIAERBA SINGOLO

# TRINCIAERBA DOPPIO



## TRINCIAERBA SINGOLO

- 🇮🇹 Telaio con attacco a 3 punti registrabile in larghezza / altezza, con trinciaerba a fili verticali per diserbo meccanico
- 🇬🇧 Frame with 3-point linkage adjustable in width / depth with wires mower for mechanical weeding
- 🇫🇷 Chassis avec attelage 3 point réglable en largeur / hauteur avec hache-herbe pour desherbe mécanique
- 🇪🇸 Chasis con ataque 3 puntos ajustables en ancho / extension con picadora de hierba para deshierbe mecánico

## TRINCIAERBA DOPPIO

- 🇮🇹 Telaio con attacco a 3 punti posteriore registrabile in larghezza / altezza, con trinciaerba a fili verticali per diserbo meccanico
- 🇬🇧 Frame with 3-point linkage adjustable in width / depth with wires mower for mechanical weeding
- 🇫🇷 Chassis avec attelage 3 point réglable en largeur / hauteur avec hache-herbe pour desherbe mécanique
- 🇪🇸 Chasis con ataque 3 puntos ajustables en ancho / extension con picadora de hierba para deshierbe mecánico







# ANDANATORE PER SARMENTI "TWIST"







## NEW VERSION







 Montato in versione SPAZZOLA  
 Vers. BRUSH  
 Vers. BROSE  
 Vers. CEPILLO



 Montato in versione SPATOLA  
 Vers. SPATULA  
 Vers. SPATULE  
 Vers. ESPATULA

Larghezza MIN filare	Larghezza MAX filare	Peso
170 cm	450 cm	280 kg

-  ANDANATORE PER SARMENTI : ALLARGAMENTO / ALZATA SIMULTANEA / REGOLATORE DI VELOCITÀ / ESCLUSIONE LATO DX O SX
-  RAKE FOR CLEARING : SIMULTANEOUS WIDENING / LIFTING / SPEED REGULATOR / RH OR LH SIDE EXCLUSION
-  RATEAU POUR NETTOYER : ÉLARGISSEMENT / LEVAGE SIMULTANÉ / RÉGULATEUR DE VITESSE / EXCLUSION LATÉRALE D OU G
-  ALINEADORA DE RESTOS DE PODA : ENSANCHAMIENTO / LEVANTAMIENTO SIMULTÁNEO / REGULADOR DE VELOCIDAD / EXCLUSIÓN DEL LADO DCH O IZQ



# TECNOLOGIA 4.0 E CENTRALINA

## TECNOLOGIA 4.0

- Con il termine "Agricoltura 4.0" intendiamo l'evoluzione dell'agricoltura di precisione, realizzata attraverso la raccolta automatica, l'integrazione e l'analisi di dati raccolti in campo grazie a tecnologie digitali 4.0. Tali informazioni sono di supporto all'agricoltore nel processo decisionale relativo alla propria attività con lo scopo ultimo di aumentare la profittabilità e la sostenibilità economica, ambientale e sociale dell'agricoltura.
- By the term "Agriculture 4.0" we mean the evolution of precision agriculture, it achieved through the automatic collection, integration and analysis of data collected thanks to digital 4.0 technologies. This information supports the farmer in the decision-making process relating to his business with the important aim of increasing the profitability and economic, environmental and social sustainability of agriculture.
- Par le terme "Agriculture 4.0", nous entendons l'évolution de l'agriculture de précision, réalisée grâce à la collecte, l'intégration et l'analyse automatiques des données collectées sur le terrain grâce aux technologies numériques 4.0. Ces informations accompagnent l'agriculteur dans le processus décisionnel relatif à son activité dans le but ultime d'accroître la rentabilité et la durabilité économique, environnementale et sociale de l'agriculture.
- Con el término "Agricultura 4.0" nos referimos a la evolución de la agricultura de precisión, lograda a través de la recolección, integración y análisis automáticos de los datos recolectados en el campo gracias a las tecnologías digitales 4.0. Esta información apoya al agricultor en la toma de decisiones relativas a su negocio con el fin último de incrementar la rentabilidad y la sostenibilidad económica, ambiental y social de la agricultura.

**NEW**



## CENTRALINA 3 PUNTI

### ■ CENTRALINA 3 PUNTI

Adatto per applicazione di intercetti ventrali di cimatrici, defogliatrici, spollatrici, piantapali, trivelle, vibratori, andanatori, prepotatrici, legatrici ecc.

### ■ CENTRALE 3 POINTS

Suitable for the application of pollers, defoliation machines, pinching machines, pole-setting machines, augers, vibrators, rakes, pre-pruners, winding machines, etc.

### ■ CENTRALE 3 POINTS





Adapté pour application de tondeuses, effeuilleuses, rogneuses, ficheuses tarières, vibreurs, balayeurs, élagueuses, lieuses etc.

### ■ CENTRALITA 3 PUNTOS





Adecuado para aplicaciones de despuntadoras, deshojadoras, cercenadoras, colocadores de postes, barrenas, vibradores, rastrillos hileradores, podadoras, gavilladoras etc.

# INTERRATORE / ARIEGGIATORE CON REGOLAZIONE MECCANICA



-  INTERRATORE DI CONCIME ED ARIEGGIATORE A REGOLAZIONE MECCANICA DELLA LARGHEZZA DEL TELAIO
-  FERTILIZERS SUBSOILING WITH MECHANICAL ADJUSTMENT OF THE WIDTH
-  SOUS SOLEURS D'ENGRAIS AVEC RÉGLAGE MÉCANIQUE DE LA LARGEUR
-  ENTERRADOR DE ABONOCON REGULACIÓN MECÁNICA DEL ANCHO







-  INTERRATORE DI CONCIME A REGOLAZIONE MECCANICA DELLA LARGHEZZA DEL TELAIO
-  FERTILIZERS SUBSOILING WITH MECHANICAL ADJUSTMENT OF THE WIDTH
-  SOUS SOLEURS D'ENGRAIS AVEC RÉGLAGE MÉCANIQUE DE LA LARGEUR
-  ENTERRADOR DE ABONO CON REGULACIÓN MECÁNICA DEL ANCHO







Modello	regolazione meccanica della larghezza sul telaio mechanical adjustment of the width on the frame réglage mécanique de la largeur sur le châssis regulación mecánica del ancho en el bastidor	
ARIEGGIATORE E INTERRATORE 1 / INTERRATORE DI CONCIME 1	cm. 20	130
ARIEGGIATORE E INTERRATORE 2 / INTERRATORE DI CONCIME 2	cm. 35	150
ARIEGGIATORE E INTERRATORE 3 / INTERRATORE DI CONCIME 3	cm. 70	190
AERATOR AND SUBSOILING 1 / SUBSOILING 1	cm. 20	130
AERATOR AND SUBSOILING 2 / SUBSOILING 2	cm. 35	150
AERATOR AND SUBSOILING 3 / SUBSOILING 3	cm. 70	190
AÉRATEUR ET SOUS-SOLEUR 1 / SOUS-SOLEUR 1	cm. 20	130
AÉRATEUR ET SOUS-SOLEUR 2 / SOUS-SOLEUR 2	cm. 35	150
AÉRATEUR ET SOUS-SOLEUR 3 / SOUS-SOLEUR 3	cm. 70	190
ESCARIFICADOR Y ENTERRADOR 1 / ENTERRADOR 1	cm. 20	130
ESCARIFICADOR Y ENTERRADOR 2 / ENTERRADOR 2	cm. 35	150
ESCARIFICADOR Y ENTERRADOR 3 / ENTERRADOR 3	cm. 70	190

# INTERRATORE / ARIEGGIATORE CON REGOLAZIONE IDRAULICA



-  INTERRATORE DI CONCIME AD ALLARGAMENTO IDRAULICO
-  FERTILIZERS SUBSOILING WITH HYDRAULIC OPERATION
-  SOUS SOLEURS D'ENGRAIS AVEC ÉLARGISSEMENT HYDRAULIQUE
-  ENTERRADOR DE ABONO CON EXTENSIÓN HIDRÁULICA







-  INTERRATORE DI CONCIME ED ARIEGGIATORE AD ALLARGAMENTO IDRAULICO
-  FERTILIZERS SUBSOILING
-  SOUS SOLEURS D'ENGRAIS
-  ENTERRADOR DE ABONO

Modello	regolazione idraulica della larghezza sul telaio hydraulic adjustment of the width on the frame réglage hydraulique de la largeur sur le châssis regulación hidráulica del ancho en el bastidor	
ARIEGGIATORE E INTERRATORE ESTENSIBILE / INTERRATORE ESTENSIBILE	allargamento IDRAULICO 50 + 50 cm	110 - 210
AERATOR AND SUBSOILING EXTENSIBLE / SUBSOILING EXTENSIBLE	HYDRAULIC operation 50 + 50 cm	110 - 210
AÉRATEUR ET SOUS-SOLEUR EXTENSIBLE / SOUS-SOLEUR EXTENSIBLE	élargissement HYDRAULIQUE 50 + 50 cm	110 - 210
ESCARIFICADOR Y ENTERRADOR EXTENSIBLE / ENTERRADOR EXTENSIBLE	extensión HIDRÁULICA 50 + 50 cm	110 - 210





# PIANTAPALI



## PIANTAPALI LATERALE

-  PIANTAPALI LATERALE
-  SIDE POLE SETTER
-  ENFONCE PIEUX LATÉRAL
-  COLOCADOR DE POSTES LATERAL

## PIANTAPALI POSTERIORE





-  PIANTAPALI POSTERIORE
-  REAR POLE SETTER
-  ENFONCE PIEUX ARRIÈRE
-  COLOCADOR DE POSTES TRASERO







# RIPUNTATORI AD ANCORE







## SPIDER 1

-  RIPUNTATORE MONOANCORA SPIDER 1
-  SUBSOILER VERS. SPIDER 1
-  SOUS-SOLEUR MODÈLE SPIDER 1
-  SUBSOLADOR MODELO SPIDER 1





-  KIT SPANDICONCIME IN ACCIAIO INOX
-  STAINLESS STEEL FERTILIZER SPREADER KIT
-  KIT ÉPANDEUR D'ENGRAIS EN INOX
-  KIT ESPARCIDOR DE FERTILIZANTES DE ACERO INOXIDABLE



## SPIDER 5

-  RIPUNTATORE 5 ANCORE SPIDER 5S (135cm) / 5 (150cm) / 5L (170cm) / 5X (190cm) CON BULLONE DI SICUREZZA FRONTALE
-  SUBSOILER SPIDER 5S (135cm) / 5 (150cm) / 5L (170cm) / 5X (190cm) WITH FRONT BREAKING BOLT SAFETY SYSTEM
-  SOUS-SOLEUR MODÈLE SPIDER 5S (135cm) / 5 (150cm) / 5L (170cm) / 5X (190cm) AVEC BOULON À RUPTURE FRONTALE
-  SUBSOLADOR MODELO SPIDER 5S (135cm) / 5 (150cm) / 5L (170cm) / 5X (190cm) CON PERNO DE ROTURA FRONTAL







-  BULLONE DI SICUREZZA FRONTALE
-  BREAKING BOLT SAFETY SYSTEM
-  BOULON À RUPTURE FRONTALE
-  PERNO DE ROTURA FRONTAL

# COLTIVATORE BASIC E ARIEGGIATORE





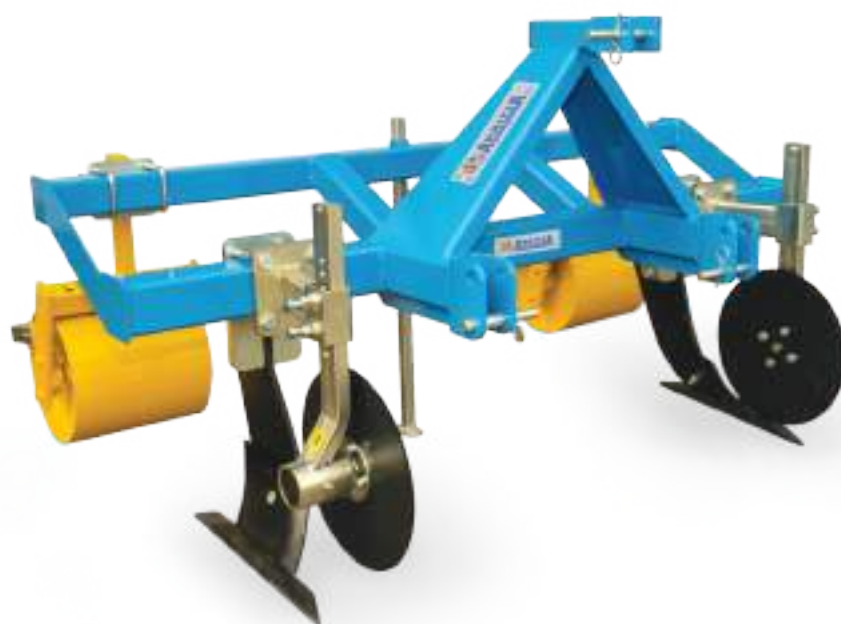

*COLTIVATORE MODELLO BASIC*

-  COLTIVATORE MODELLO BASIC
-  CULTIVATOR VERSION BASIC
-  CULTIVATEUR MODÈLE BASIC
-  CULTOR MODELO BASIC







*ARIEGGIATORE PER VIGNETO "MAXI"*





-  ARIEGGIATORE PER VIGNETO
-  AERATOR FOR VINEYARD
-  AÉRATEUR POUR VIGNE
-  ESCARIFICADOR PARA VINA

# VIBROCULTORE







-  VIBROCULTORE MOD. V
-  VIBROCULTIVATOR VERS. V
-  VIBROCULTEUR MODÈLE V
-  VIBROCULTOR MODELO V







-  VIBROCULTORE MOD. VB
-  VIBROCULTIVATOR VERS. VB
-  VIBROCULTEUR MODÈLE VB
-  VIBROCULTOR MODELO VB







-  VIBROCULTORE MOD. VBR
-  VIBROCULTIVATOR VERS. VBR
-  VIBROCULTEUR MODÈLE VBR
-  VIBROCULTOR MODELO VBR







-  COLTIVATORE MOD. CLP
-  CULTIVATOR VERS. CLP
-  CULTIVATEUR MODÈLE CLP
-  CULTIVADOR MODELO CLP

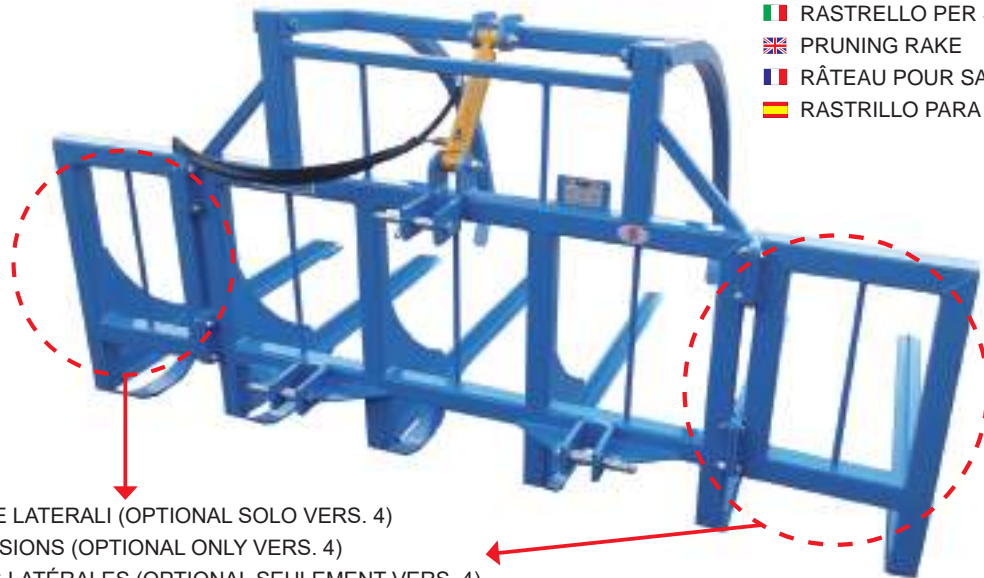

## RSA - BI 4 / 6





-  RASTRELLO PER SARMENTI
-  PRUNING RAKE
-  RÂTEAU POUR SARMENTS
-  RASTRILLO PARA SARMIENTOS







-  PROLUNGHE LATERALI (OPTIONAL SOLO VERS. 4)
-  SIDE EXTENSIONS (OPTIONAL ONLY VERS. 4)
-  RALLONGES LATÉRALES (OPTIONAL SEULEMENT VERS. 4)
-  EXTENSIONES LATERALES (OPTIONAL SÓLO PARA LA VERS. 4)







## RSA - BI 5

-  RASTRELLO PER SARMENTI
-  PRUNING RAKE
-  RÂTEAU POUR SARMENTS
-  RASTRILLO PARA SARMIENTOS

-  VASCA INFORCABILE INOX
-  INOX LIFTABLE TANK
-  CUVE ENFOURCHABLE INOX
-  CUBA CON ENGANCHES INOX



-  BENNA IDRAULICA
-  HYDRAULIC BUCKET
-  CHARGEUR HYDRAULIQUE
-  PALA HIDRÁULICA



🇮🇹 APPLICAZIONI MOTRICI SOLO PER I MODELLI R e FULL  
🇬🇧 ONLY FOR R AND FULL MODEL

🇫🇷 UNIQUEMENT POUR LES MODELES R ET FULL  
🇪🇸 SOLO PARA MODELOS R Y FULL



Fresino circolare (anche con spazzola)  
Circular cutter (also with brush)  
Fraise circulaire (aussi avec brosse)  
Fresa circular (tambien con escobilla)



Testata trinciaerba a lame cm 50  
Mower head with blades cm 50  
Tete hache-herbe a lames cm 50  
Cabezal picadora de hierba a cuchillas cm 50



Scalzatore rotativo con alette  
Rotative plant lifter with fins  
Dechasseur rotatif avec ailettes  
Arrancador giratorio con aletas



Spollonatrice idraulica  
Hydraulic rotary brush  
Epampreuse hydraulique  
Cercenadora hidraulica



Dischiera scalzante  
Traction lifting disk  
Groupe disques dechasseurs  
Portadiscos arrancadores



Trinciaerba a fili corti  
Mower head with short wires  
Hache-herbe avec fils court  
Picadora de hierba de hilos



Trinciaerba a fili verticali  
Vertical wires mower  
Hache-herbe a fils verticaux  
Picadora de hierba de hilos verticales

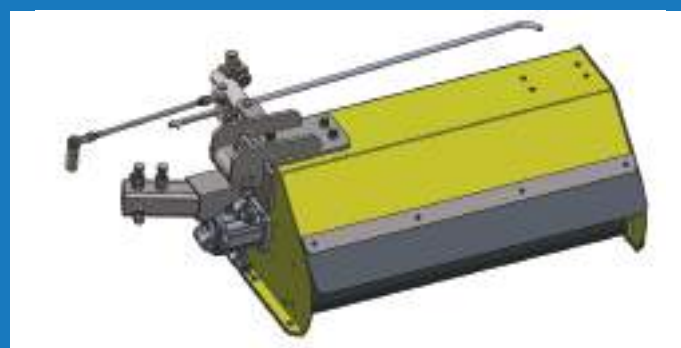

Testata mini-trincia cm 80  
Mini-shredder head cm 80  
Tete mini broyeur cm 80  
Cabezal mini cosechadora cm 80



Testata trinciaerba a lame cm 80  
Mower head with blades cm 80  
Tete hache-herbe a lames cm 80  
Cabezal picadora de hierba a cuchillas cm 80

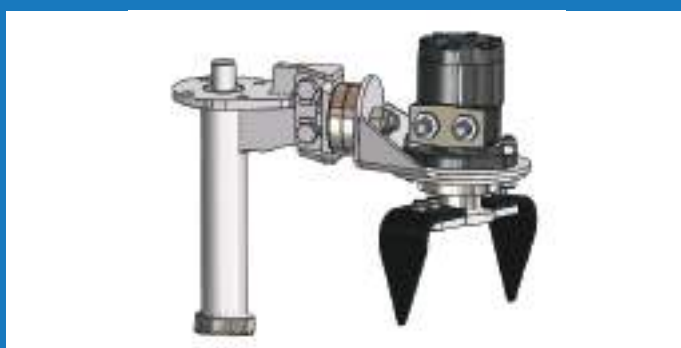

Kit fresino circolare per lama interfilare cm 55 / 65  
Circular cutter hydraulic kit for inter-row blade cm 55 / 65  
Kit hydraulique fraise circulaire pour lame intercep  
Kit fresa circular para cuchilla intercepas cm 55 / 65

 APPLICAZIONI NON MOTRICI  
 APPLICATIONS FOR NO-POWER TOOLS

 APPLICATIONS POUR OUTILS NON MOTRICE  
 APLICACIONES DE IMPLEMENTOS NO MOTRICES



Dischiera 2 dischi rinalzanti orientabili con pulitore  
 2 ridger discs with cleaner on first disk  
 2 disque orientable à rehausser avec nettoyant  
 2 discos aporcadores orientables con limpiadores



Disco dentato rinalzante orientabile  
 Adjustable disk for earthing  
 Disque denté à rehausser orientable  
 Disco dentado embutidor orientable



Disco apripista bombato orientabile  
 Adjustable rounded tiller disk  
 Disque buteur bombé orientable  
 Disco de empuje abombado orientable



Pulisciceppo per kit interfilare  
 Stump cleaner for inter-row kit  
 Cureceps pour kit intercep  
 Limpiador de cepas para kit cuchilla intercepas



Pulisciceppo su dischiera  
 Stump cleaner on traction 3 disks  
 Cureceps sur groupe 3 disques  
 Limpiador de cepas 3 portadiscos arrancadores



Stella a dita diam. mm 700  
 Fingerstar diam. mm 700  
 Étoile aux doigts diam. mm 700  
 Estrella a dedos diam. mm 700



Dischiera sarchiatrice stellata a 2 / 3 stelle  
 Starcut blade set with 2 / 3 stars  
 Groupe disques sarclouse étoile a 2 / 3 étoile  
 Discos escardadoras estrellado con 2 / 3 estrellas



Disco apripista diam. mm 320  
 Tiller disk diam. mm 320  
 Disque buteur diam. mm 320  
 Disco de empuje diám. mm 320



Porta tastatore no-stop  
 No-Stop feeler pin holder  
 Porte-tateur no-stop  
 Porta palpador no-stop



Rullo a gabbia / Rullo a spuntoni / Rullo chiuso / Rullo packer  
 Cage roller / Spike roller / Closed roller / Packer roller  
 Rouleau a cage / Rouleau a pointes / Rouleau ferme / Rouleau packer  
 Rodillo de jaula / Rodillo de clavos / Rodillo cerrado / Rodillo packer



Porta tastatore oscillante  
 Oscillating feeler pin holder  
 Porte-tateur oscillant  
 Porta palpador oscilante



Vomere scalzante con pulsciceppo cm 45/55  
 Plant lifting ploughshare with stump cleaner cm 45/55  
 Soc déchausseuse avec cureceps cm 45/55  
 Reja de arado arrancadora limpiador de cepas cm 45/55



Stella a dita diam. mm 540  
 Fingerstar diam. mm 540  
 Étoile aux doigts diam. mm 540  
 Estrella a dedos diam. mm 540



Kit lama interceppo  
 Inter-row blade kit  
 Kit lame ouillère  
 Kit cuchilla intercepas



Kit aratro scalzante mod. P  
 Plant lifting plough kit mod. P  
 Kit charrue déchausseuse mod. P  
 Kit arado arrancador mod. P



Kit lama interfilare mod. P  
 Inter-row blade kit mod. P  
 Kit lame ouillère mod. P  
 Kit cuchilla intercepas mod. P

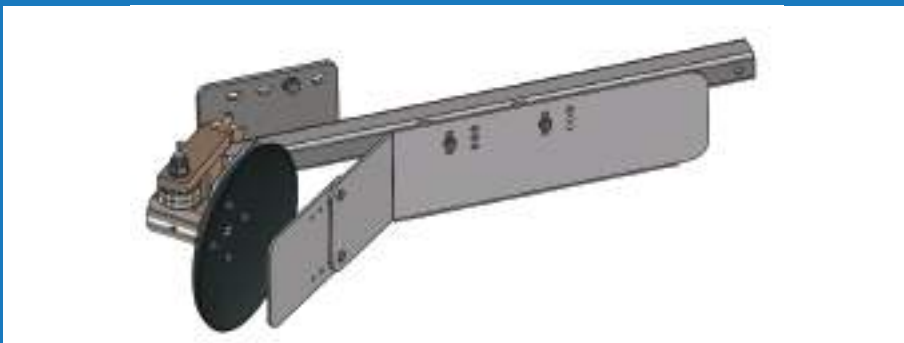

Paraterra con disco delimitatore orientabile per lavorazione interfilare ristretta.  
 Fender with adjustable delimiting disc for limited inter-row work to apply with circular cutter diam. 250 or 45 cm blade  
 Défense pour la terre avec disk delimitateur réglable pour travail du sol étroit à montée avec la fraise circulaire diam. 250 ou avec la lame de 45 cm  
 Paratierra con disco delimitator ajustable para labranza limitada aplicar con fresa circular diám. 250 o cuchilla 45 cm



Paraterra rinforzato  
 Reinforced fender ground cover  
 Défense pour la terre renforcée  
 Paratierra reforzado

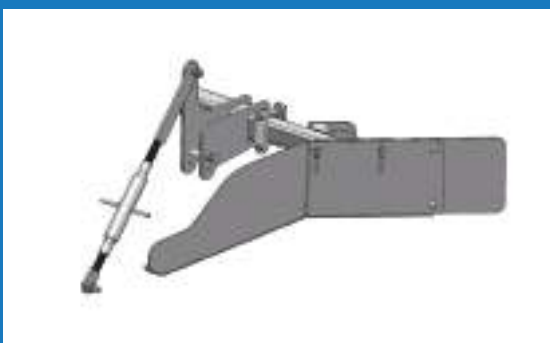





Paraterra per Frutteto (anche con disco delimitatore)  
 Ground cover for Orchard (also with delimiting disc)  
 Défense terre pour Arboricole (aussi avec disk delimitateur)  
 Paratierra para Frutales (también con disco delimitator)



Paraterra con ammortizzatore per Ventrale e Modello P  
 Ground fender with shock absorber for Ventrale and Model P  
 Garde au sol avec amortisseur pour Ventrale et Modèle P  
 Protector de suelo con amortiguador para Ventrale y Model P





# VALVOLA BREVETTATA NO-STOP



-  Permette di far funzionare il sistema interceppo gestito da una singola pompa senza interruzioni, anche quando la rotazione del motore idraulico dell'utensile dovesse arrestarsi.
-  Allows to make work the inter-row system managed by a single pump without interruptions, when the rotation of the hydraulic utensil motor had to halt.
-  Permet de faire fonctionner le système intercep géré par une pompe unique sans interruptions, aussi quand la rotation du moteur hydraulique de l'outil dût s'arrêter.
-  Permite de hacer funcionar el sistema intercepas administrado por una bomba individual sin interrupciones, también cuando la rotación del motor hidráulico del utensilio tuviera que pararse.





## BLOCCO ROTAZIONE ROTATION STOPPING



-  Blocco della rotazione dei fili della spollonatrice e del trinciaerba (optional da applicare solo al momento dell'ordine)
-  Rotary brush's and vertical wires mower rotation block (optional, applicable only when ordering)
-  Bloc de la rotation des fils epampreuse et hache-herbe (option applicable uniquement lors de la commande)
-  Bloque de la rotación de los hilos de la cercenadora hidraulica y picadora de hierba (opcional aplicable sólo en el momento del pedido)

## DISATTIVA TASTATORE FEELER-OFF BUTTON



-  Pulsante disattiva tastatore per lavorare con l'utensile nell'erba alta, per evitare che il tastatore rientri anche quando non occorre (optional da applicare solo al momento dell'ordine)
-  Feeler-off button, to work in long grass, to prevent the feeler returning when not necessary optional, applicable only when ordering)
-  Bouton de désactivation du tâteur pour travailler avec l'outil dans l'herbe haute, afin d'éviter que le tâteur ne rentre quand cela n'est pas nécessaire (option applicable uniquement lors de la commande)
-  Pulsador desactivación del palpador para trabajar con el implemento en la hierba alta, para evitar que el palpador se retraiga incluso cuando no sea necesario. (opcional aplicable sólo en el momento del pedido)

# SISTEMA DI SALITA E DISCESA BREVETTATO



- Sistema di salita e discesa su guide: consente di spostare in modo indipendente le 2 parti lavoranti abbassandole di 20 cm (utensile interfilare e DX e utensile interfilare SX). L'attrezzo può essere utilizzato per la lavorazione combinata di un filare e di una (o entrambe) le zone interfilari.
- Up/down hydraulic system with tracks: has the benefit of moving the machine's 2 operating elements independently (right inter-row and left interrow tool) lifting the lateral frames by 20 cm off the ground. The machine can also be used to operate on row and the (or both) interrow areas.
- Système de montée/descente sur guides: permet on a l'avantage de déplacer de manière indépendante les 2 parties en exercice (outil inter-rangs droit et outil inter-rangs gauche), en soulevant du sol les châssis latéraux de 20 cm. L'équipement pouvant être employé pour le travail combiné d'un rang et d'une (ou des deux) zone inter-rangs qui lui est adjacente.
- Sistema hidráulico de subida/bajada sobre guías es que existe la posibilidad de desplazar de forma independiente las 2 partes que trabajan (herramientas para interlineado derecho y herramientas para interlineado izquierdo), levantando del suelo los bastidores laterales de 20 cm. La herramienta preparada de esta forma presenta una flexibilidad de uso notable para que pueda ser utilizado para el trabajo combinado de una hilera y de una (o ambas) las zonas interhileras adyacentes.

## REVERSIBILITÀ TOTALE TOTAL REVERSIBILITY

### VERSIONE REVERSIBILE



- Reversibilità completa di attacco a 3 punti anteriore/posteriore e tripla presa di forza con cardano: posteriore 540 g/min DX e anteriore 540 g/min DX + 1000 g/min SX (non applicabile su versioni 1XS, 1S, 1 e telescopiche)
- Reversibility complete of front/rear 3-points coupling and triple power take-off with cardan: RH 540 rpm rear and front RH 540 rpm + LH 1000 rpm (not available on versions 1XS, 1S, 1 and telescopic)
- Réversibilité complète d'attelage à 3 points antérieurs/postérieure et triple prise de force avec cardan: postérieur 540 t/min D et antérieur 540 t/min D + 1000 t/min G (pas applicable sur versions 1XS, 1S, 1 et télescopique)
- Reversibilidad completa con enganche de tres puntos delantero/trasero y triple toma de fuerza con cardan: trasero 540 rpm DCH. y delantero 540 rpm DCH. + 1000 rpm IZQ. delantero (no aplicable en versiones 1XS, 1S, 1 y telescópico)

## QUARTA PRESA DI FORZA FOURTH POWER TAKE-OFF



- Quarta presa di forza anteriore 540 g/min SX (necessità della reversibilità completa di attacco a 3 punti anteriore/posteriore e tripla presa di forza con cardano CODE 1362)Q
- Fourth power take-off 540 rpm LH (needed reversibility complete of front/rear 3-points coupling and triple power take-off with cardan CODE 1362)
- Quatrième prise de force antérieur 540 t/min G (besoin de la réversibilité complète d'attelage à 3 points antérieurs/postérieure et triple prise de force avec cardan CODE 1362)
- Cuarto toma de fuerza 540 rpm IZQ. (necesitar reversibilidad completa con enganche de tres puntos delantero/trasero y triple toma de fuerza con cardan CODE 1362) 540 g/bilit

# PUNTI DI FORZA

SOLO COMPONENTISTICA ITALIANA  
ITALIAN COMPONENTS ONLY  
MATÉRIEAUX DE PRODUCTION ITALIENNE  
MATERIALES DE PRODUCCIÓN ITALIANA

SISTEMI BREVETTATI  
PATENTED SYSTEMS  
SYSTÈMES BREVETÉS  
SISTEMAS PATENTADOS

IMPIANTO IDRAULICO OPPORTUNAMENTE DIMENSIONATO CON SISTEMA DI CONTROLLO  
PROPERLY DIMENSIONED HYDRAULIC SYSTEM WITH CONTROL SYSTEM  
SYSTÈME HYDRAULIQUE CORRECTEMENT DIMENSIONNÉ AVEC SYSTÈME DE CONTRÔLE  
SISTEMA HIDRÁULICO DIMENSIONADO ADECUADAMENTE CON SISTEMA DE CONTROL

CENTRALINA ELETTRONICA DI CONTROLLO,  
VERIFICA ALLARMI E AUTOTEST  
ELECTRONIC CENTRAL UNIT, ALARMS  
VERIFICATION AND AUTOTEST  
UNIDAD DE CONTROL ELECTRÓNICA,  
VERIFICACIÓN DE ALARMAS Y AUTOTEST  
CENTRALE ÉLECTRONIQUE, VÉRIFICATION  
D'ALARME ET AUTO-TEST

FINO A 23 FUNZIONI SU JOYSTICK  
UP TO 23 FUNCTIONS ON THE JOYSTICK  
JUSQU'À 23 FONCTIONS SUR LE JOYSTICK  
HASTA 23 FUNCIONES EN EL JOYSTICK

FILTRI DI ALTA PRESSIONE IN GHISA SFEROIDALE CON  
INDICATORE INTASAMENTO

HIGH PRESSURE FILTERS IN SPHEROIDAL CAST IRON  
WITH CLOGGING INDICATOR

FILTRES HAUTE PRESSION EN FONTE SPHÉROÏDALE  
AVEC INDICATEUR DE COLMATAGE

FILTROS DE ALTA PRESIÓN DE FUNDICIÓN ESFEROIDAL  
CON INDICADOR DE COLMATACIÓN

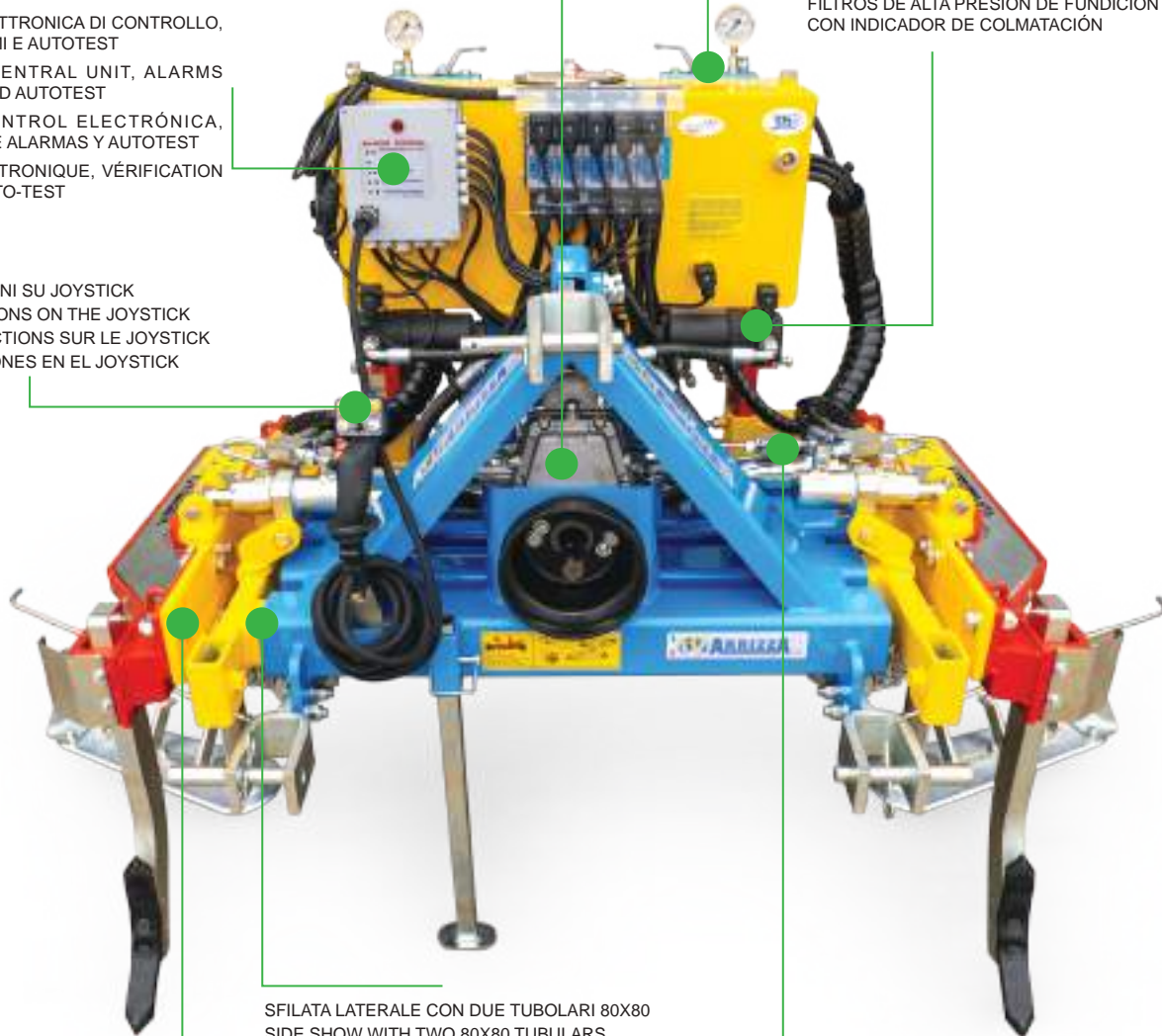

SFILATA LATERALE CON DUE TUBOLARI 80X80  
SIDE SHOW WITH TWO 80X80 TUBULARS  
SIDE SHOW AVEC DEUX TUBULAIRES 80X80  
SIDE SHOW CON DOS TUBULARES 80X80





INCLINAZIONE ED INTERFILARE SONO DOTATI DI  
BOCCOLE INI ANTIUSURA, INTERCAMBIABILI E  
LUBRIFICATI





INCLINATION AND INTER-ROW ARE EQUIPPED WITH  
ANTI-WEAR INI, INTERCHANGEABLE AND LUBRICATED  
BUSHINGS

L'INCLINAISON ET L'INTER-RANGEMENT SONT ÉQUIPÉS  
DE DOUILLES INI ANTI-USURE, INTERCHANGEABLES ET  
LUBRIFIÉES

INCLINACIÓN E INTERHILE ESTÁN EQUIPADOS CON  
CASQUILLOS INI ANTIDESGASTE, INTERCAMBIABLES Y  
LUBRICADOS

ALLARGAMENTO SIMULTANEO CON ESCLUSIONE LATO SX  
SIMULTANEOUS ENLARGEMENT WITH LEFT SIDE EXCLUSION  
ENLARGEMENT SIMULTANÉ AVEC EXCLUSION CÔTÉ GAUCHE  
AMPLIACIÓN SIMULTÁNEA CON EXCLUSIÓN LADO IZQUIERDO

 IMPLEMENTAZIONE INDUSTRIA 4.0  
 INDUSTRIA 4.0 IMPLEMENTATION  
 IMPLÉMENTATION INDUSTRIA 4.0  
 IMPLEMENTACIÓN INDUSTRIA 4.0

 STRUTTURE CON ACCIAI DI ALTA QUALITÀ  
 HIGH QUALITY STEEL STRUCTURES  
 STRUCTURES EN ACIER DE HAUTE QUALITÉ  
 ESTRUCTURAS CON ACEROS DE ALTA

 PORTA ATTREZZI POLIVALENTE  
 MULTI-PURPOSE TOOL CARRIER  
 PORTE-OUTILS MULTI-USAGES  
 PORTAHERRAMIENTAS MULTIUSO

INNESTI RAPIDI INDUSTRIALI A FACCIA PIANA PER APPLICAZIONE UTENSILI MOTRICI

INDUSTRIAL QUICK COUPLINGS WITH FLAT FACE FOR APPLICATION OF DRIVE TOOLS

RACCORDS RAPIDES INDUSTRIELS À FACE PLATE POUR L'APPLICATION D'OUTILS D'ENTRAÎNEMENT

INNESTI RAPIDI INDUSTRIALI A FACCIA PIANA PER APPLICAZIONE UTENSILI MOTRICI

ASTA NUMERATA PER UNA PERFETTA REGOLAZIONE DI PROFONDITÀ

NUMBERED AUCTION FOR PERFECT DEPTH ADJUSTMENT

VENTE NUMÉROTÉES POUR UN RÉGLAGE PARFAIT DE LA PROFONDEUR

SUBASTA NUMERADA PARA UN PERFECTO AJUSTE DE PROFUNDIDAD

RECUPERO CONDENSATO OLIO  
 OIL CONDENSATE RECOVERY  
 RÉCUPÉRATION DES CONDENSATS D'HUILE  
 RECUPERACIÓN DE CONDENSADOS DE ACEITE

SISTEMA ANTIVIBRANTE REGOLABILE  
 ADJUSTABLE ANTIVIBRATION SYSTEM  
 SYSTÈME ANTI-VIBRATION RÉGLABLE  
 SISTEMA ANTIVIBRATORIO AJUSTABLE

RICHIAMO D'EMERGENZA TOTALMENTE ELETTRICO

FULLY ELECTRIC EMERGENCY RECALL

APPEL D'URGENCE ENTIÈREMENT ÉLECTRIQUE

LLAMADA DE EMERGENCIA TOTALMENTE ELÉCTRICA

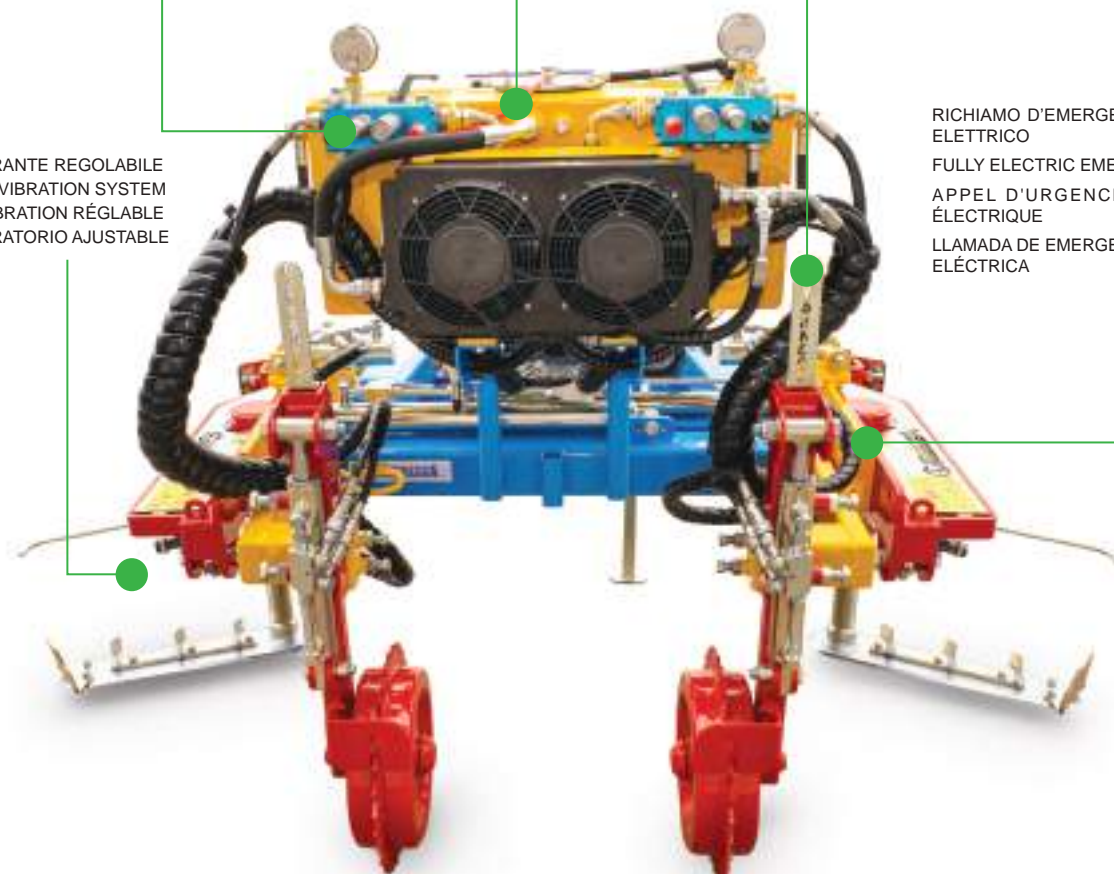

LE RUOTE SI ALLARGANO CON IL SISTEMA INTERFILARE PER ADEGUARSI ALLE SCONNESIONI DEL TERRENO

THE WHEELS WIDEN WITH THE INTER-ROW SYSTEM TO ADAPT TO THE DISCONNECTIONS OF THE GROUND

LES ROUES S'ÉLARGISSENT AVEC LE SYSTÈME INTER RANG POUR S'ADAPTER AUX DÉCONNEXIONS DU TERRAIN

LAS RUEDAS SE ENANCHAN CON EL SISTEMA INTERHILE PARA ADAPTARSE A LAS DESCONEXIONES DEL TERRENO

RUOTE DENTATE CON CRESTE ANTISBANDAMENTO  
 TOOTHED WHEELS WITH ANTI-SKID RIDGES  
 ROUES DENTÉES AVEC RAINURES ANTIDÉRAPANTES  
 RUEDAS DENTADAS CON BANDA ANTIDESLIZANTE

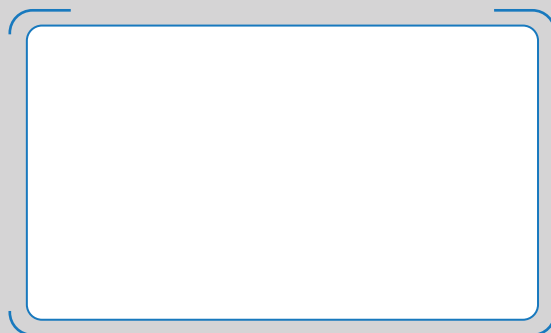

Tutte le macchine prodotte da Arrizza s.r.l. sono costruite nel pieno rispetto della normativa italiana sulla sicurezza delle macchine agricole (DPR 547 del 1955) e la Comunità europea.

All machines manufactured by Arrizza LTD are built in full compliance with Italian regulations on the safety of agricultural machinery (Presidential Decree 547 of 1955) and the European Community.



ARRIZZA SRL  
VIA PIANTONATA, 18 - 66022 FOSSACESIA (CH) - ITALY  
TEL: (+39) 0872 60497 - FAX: (+39) 0872 620937  
[www.arrizza.it](http://www.arrizza.it) - [info@arrizza.it](mailto:info@arrizza.it) - f @ Arrizza srl